

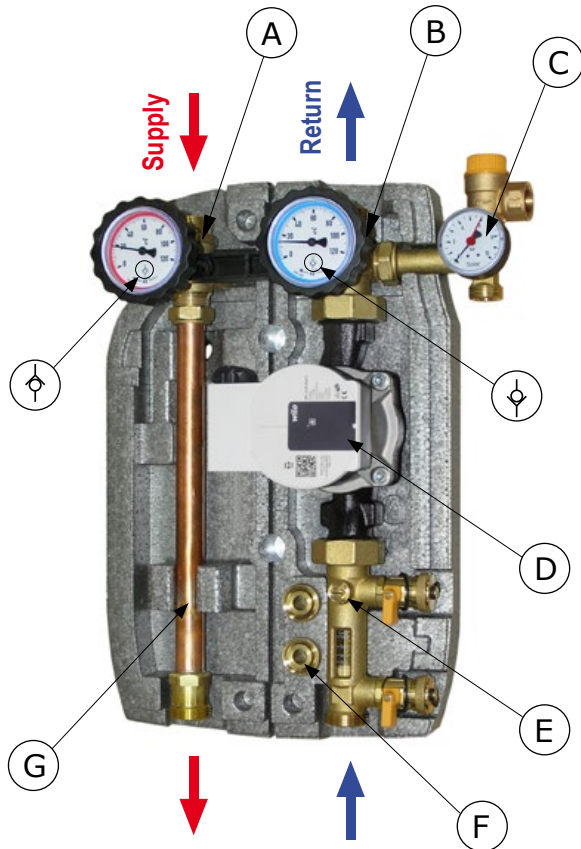

Installation instructions



DIMENSIONS

EPP Insulation box: Side opening on the base for the safety group. A dedicated opening allows to read the flow rate without removing the lid. Dimensions: 277x425x150 mm.

A special metal back plate fasten the unit to the insulation and allows easy installation both on the wall and on the storage tank.

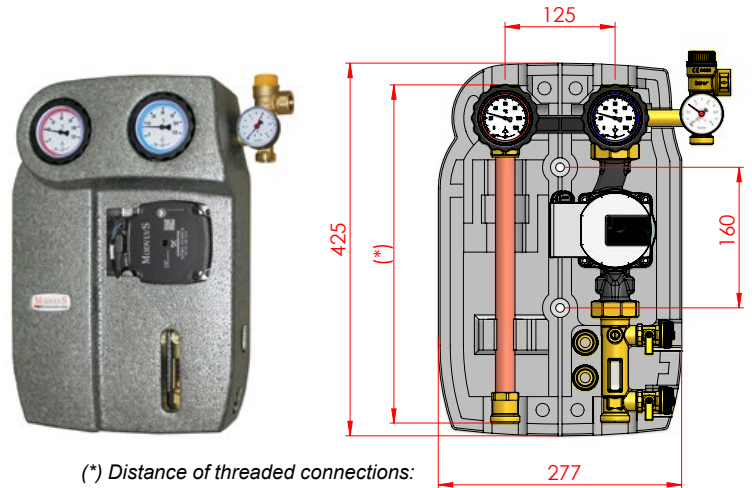

(*) Distance of threaded connections:
22 mm compression end: 405 mm
3/4\"/>

MAIN COMPONENTS

- A. Supply ball valve provided with 10 mbar check valve which can be excluded, supplied with in-handle red ring thermometer, range 0-120°C.
- B. Return ball valve provided with 10 mbar check valve which can be excluded, supplied with in-handle blue ring thermometer, range 0-120°C.
- C. 6 bar safety unit with 0-10 bar pressure gauge with connection to the flexible hose of expansion vessel (not included).
- D. Synchronous high efficiency circulating pump externally controlled by PWM signal.
- E. Flowmeter with flow regulation with filling and draining valves.
- F. Pair of hose unions for filling and draining.
- G. Supply connection pipe.

MAINTENANCE

To operate an incidental service/replacement of the circulating pump, close the ball valve (B) and regulation rod (E) by rotating clockwise. Once maintenance is over, open again the two ball valves and restore the pressure of the system.

TECHNICAL FEATURES

PN 10. Constant temperature 120°C;
(short time temperature: 160°C for 20 s).
Available external connections:
22 mm compression, 3/4\"/>

FIELD OF USE

For power up to 50 kW.

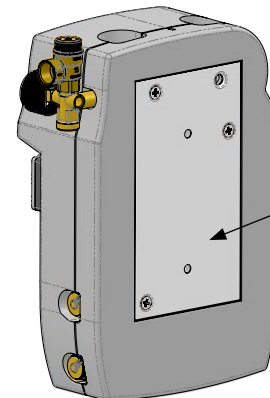

Metal back plate to fasten the unit to a wall or to a water tank.

ø10 fastening holes on the back plate.
Special passages on the insulation allow fastening without having to disassemble the unit.

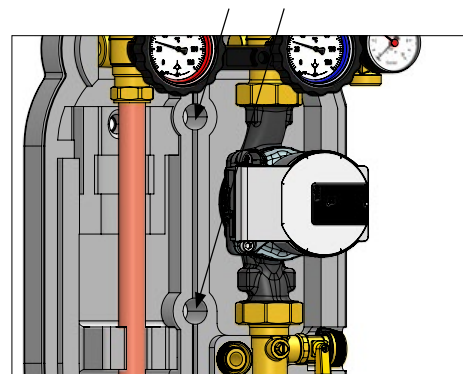

SAFETY: Temperatures reached by the fluid can be high enough to cause scalds and burns. The unit must be installed by a qualified installer. After the installation, check the tightness of the connections to avoid leaks during working operations.

SOLAR PUMPING STATION S2 SOLAR 2

COMPONENTS AND OPERATION



10 mbar check valve

“Solar” check valve built-in in the ball valve, both in the supply and in the return way. It guarantees tightness and low pressure drops. To exclude the check valve, for example in case of draining the system, turn the handle 45° clockwise.



Safety unit

The safety unit, CE and TÜV approved, protects the installation from overpressures. It is calibrated at 6 bar and over this pressure the unit intervenes. It is also provided with a ø50 mm 0-10 bar pressure gauge and with a connection to the expansion vessel by means of a 3/4" flexible kit (optional).



Safety unit: the blow-off outlet is marked by an arrow on the body of the valve. Install a blow-off pipe such that neither injury to a person nor damage to property can be caused by the blow out liquid.

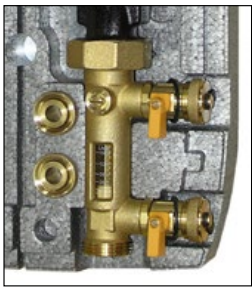

Flowmeter regulator

The flowmeter allows to read the flow rate as well as to fill easily the system. Thanks to a 3-way ball, when the valve is closed the usual circulation is cut off and it is possible to use the side filling valve to fill the system. There is also another side valve, for the draining. The proximity of the two valves helps these operations, minimizing the distance between the filling and the draining. The flow rate is shown by the special sliding cursor. Four flowmeters are available with different intervals of measurement: 1-6 L/min, 2-12 L/min, 8-28 L/min and 8-38 L/min. The flowmeter regulator, and therefore the pumping unit, must be mounted only vertically.

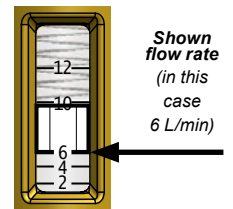

The flow rate is shown taking as reference the lower edge of the sliding cursor.

The integrated ball valve also allows fine adjustment of the system flow rate. However, it is recommended and preferable to adjust the flow rate by controlling the high efficiency synchronous circulating pump.

FILLING THE SYSTEM

1. Check the connections to the circuit and to the expansion vessel;
2. Make sure both ball valves (A) and (B) are open;

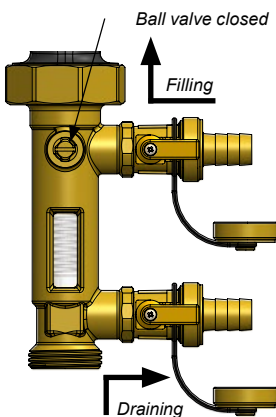

3. Remove the plugs from the side valves and connect the hose unions, by connecting them to the filling device of the system;
4. Close the flowmeter ball valve and open the side filling and draining valves;
5. Fill the system up to a pressure level set by the project;

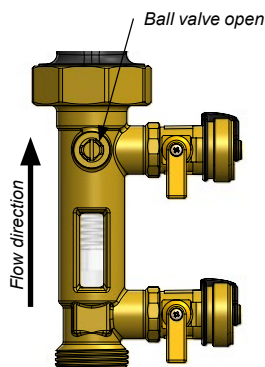

6. Close side valves, remove hose unions and re-screw plugs;
7. To avoid any accidental opening of the side taps it is advisable to block the levers in the closed position as illustrated alongside;
8. Reopen the ball valve of the flow meter;

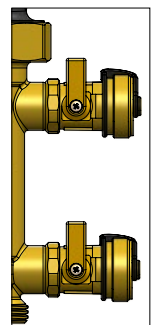

Blocking the filling/draining levers: unscrew the fixing screw, take out the lever and place it again turning it by 180°.

9. Start the circulating pump and check that there are no leaks from the connections;
10. After a few minutes of circulation, deaerate the circuit;
11. Adjust the flow rate of the circuit, preferably by acting on the control of the high efficiency synchronous circulating pump, alternatively carry out the adjustment by acting on the ball valve of the flow meter, until the desired flow rate is read on the indicator;
12. After a few hours of operation, check again the system pressure, the tightness of the connections and repeat deaeration.