

DOMVS CLIMA - CONTROL UNIT WITH ROTARY MIXING VALVE



SAFETY: Please read carefully the mounting and the setting working instructions before starting the unit, in order to avoid accidents and failures caused by an incorrect use of the product. Please keep this manual for future consultations. Please also read the technical features and the instructions of the controller.

List and basic technical features of the main components

The components are supplied unassembled: you must assemble them to get the mounted pump unit as shown in the following illustration.

(C) Safety thermostat

Safety thermostat, with 55°C activation temperature, to be connected to the Power Box.

(R1) High efficiency circulating pump

Adjustable speed with PWM control, according to real needs of the system.

(B) Power Box

Power supply and control unit to be inserted into the distribution box. Power cable, circulating pump, supply temperature sensor and actuator are already pre-wired.



(B)



(A)

(A) Room thermostat

Room thermostat with TFT capacitive touch panel for remote control of the heating/cooling system. The control unit must be positioned in the living room at a height between 120 and 160 cm. The connecting cable is supplied separately according to the required length.

(D) Air vent valve

Automatic air vent: it helps to vent the system from the air microbubbles present in the circuit.

(F) Connection to the inlet of manifold

Straight or eccentric connection to be ordered separately depending on the manifold to be connected (straight, eccentric 15 mm or 30 mm).

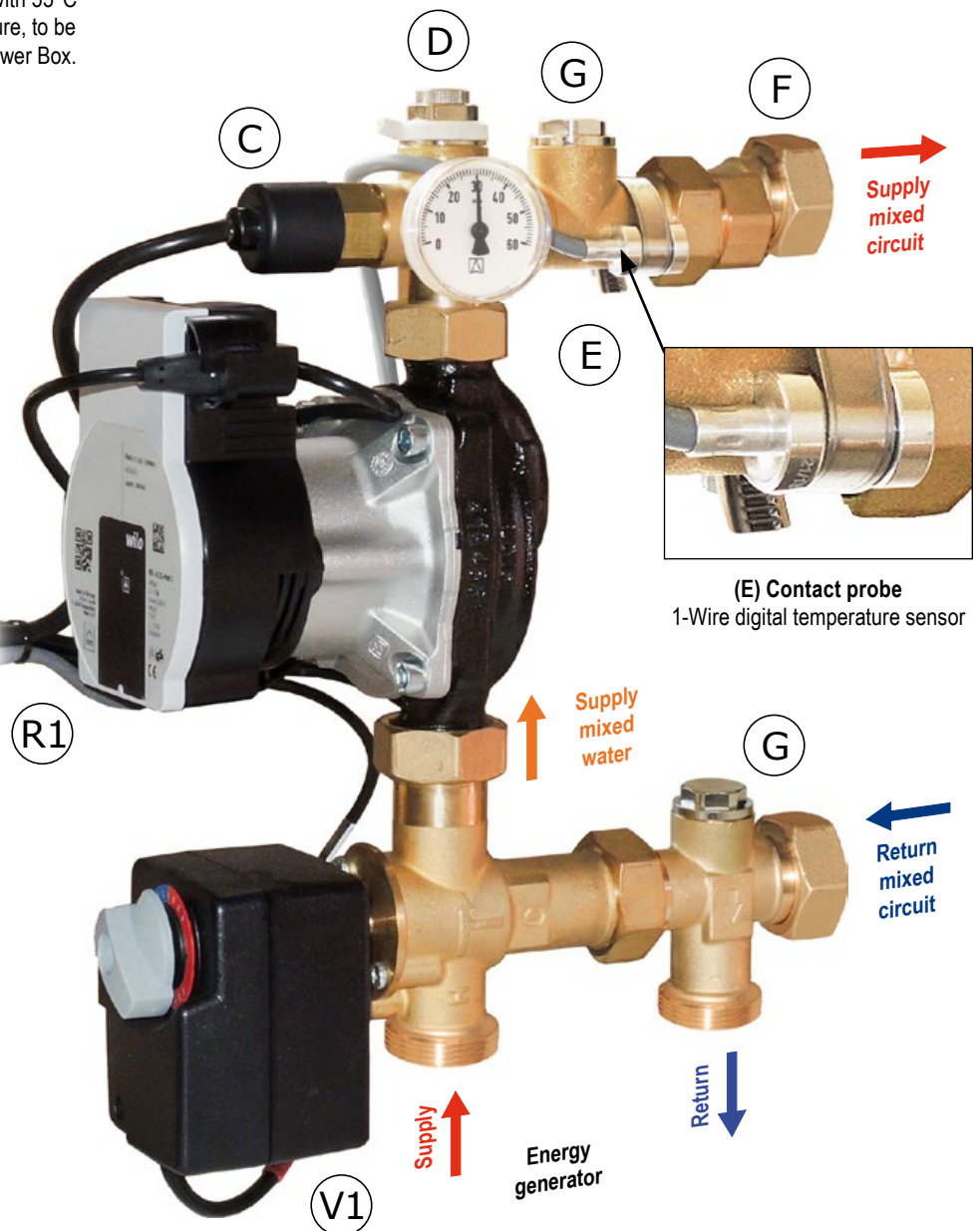

(R1)

(V1)

(E) Contact probe
1-Wire digital temperature sensor

(G) By-Pass connection
Ready for the connection of the overpressure balancing valve.

(V1) Motorized Mixing valve

3 way compact rotary mixing valve with high hydraulic performances (Kvs 6,8). With 0-10V proportional servomotor.

DOMVS CLIMA - CONTROL UNIT WITH ROTARY MIXING VALVE

Hydraulic connection scheme

Caution. The scheme is purely indicative: no hydraulic components of security or devices required by specific rules or laws are represented.

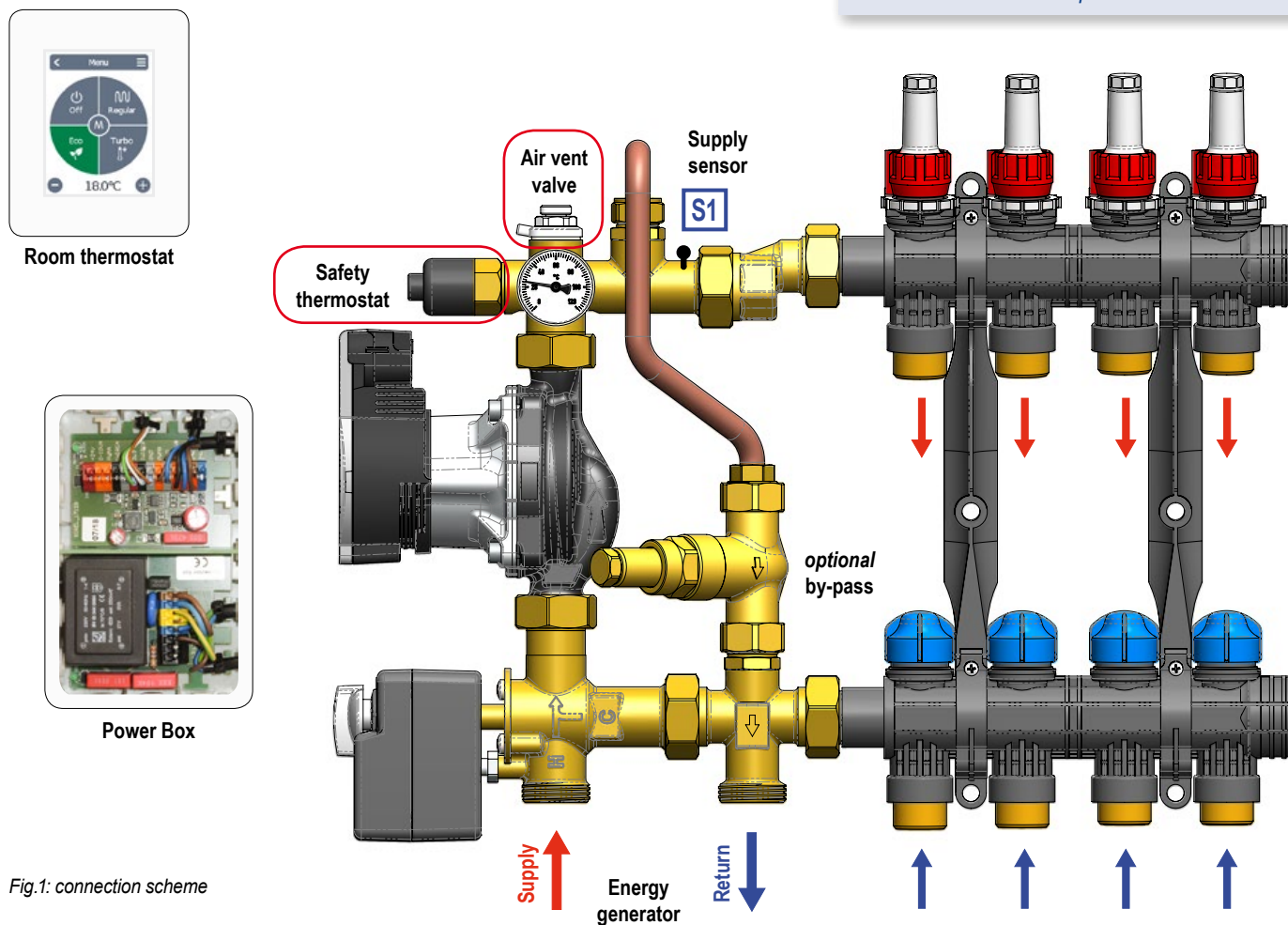

Fig.1: connection scheme

Field of utilization

HEATING MODE

For power up to 17 kW (with Δt 8 K) and a maximum flow of 1800 l/h.

COOLING MODE

For power up to 6,5 kW (with Δt 3 K) and a maximum flow of 1800 l/h.

Kvs value: 4,6

Approximate data calculated with 8 m head circulating pump

Indicative size of the radiant system: up to 200 m²;
residual head: 5 mH₂O

Technical data of circulating pump

Wilo Para 15/8 iPWM: 2-75 W ; I_{max} = 0,38 A

Technical features

Maximum working pressure: **PN 10**
 Maximum temperature: **100 °C**
 Adjustment range (heating mode): **20÷55°C (*)**
 Adjustment range (cooling mode): **(**)**
 Centre distance: **210 mm**
 Connection to manifold: **1" Rotary male or 1" Swivel nut**

Connection to the primary circuit: **1" Male with centre distance 96 mm**

(*) Temperature limited by the safety thermostat

(**) Selectable temperature: fixed or calculated according to the condensation curve

Materials

Fittings	Gaskets	Air Vent	Circulating pump
Copper alloy CW617N	EPDM	Brass and ABS	Body in composite material

DOMVS CLIMA - CONTROL UNIT WITH ROTARY MIXING VALVE

Characteristic curve

Characteristic curve of the circulating pump and the control unit

The diagram shows how to calculate the residual head of the circulating pump. When defining the maximum required flow (as in example 1500 L/h), it can be seen from the graph that the circulating pump at this range has a head of 7.33 mH₂O, while the control unit has 1.09 mH₂O of head's loss. As a result, the available head of the circulating pump, in order to top the head's loss of the mixed circuit, is 6.24 mH₂O.

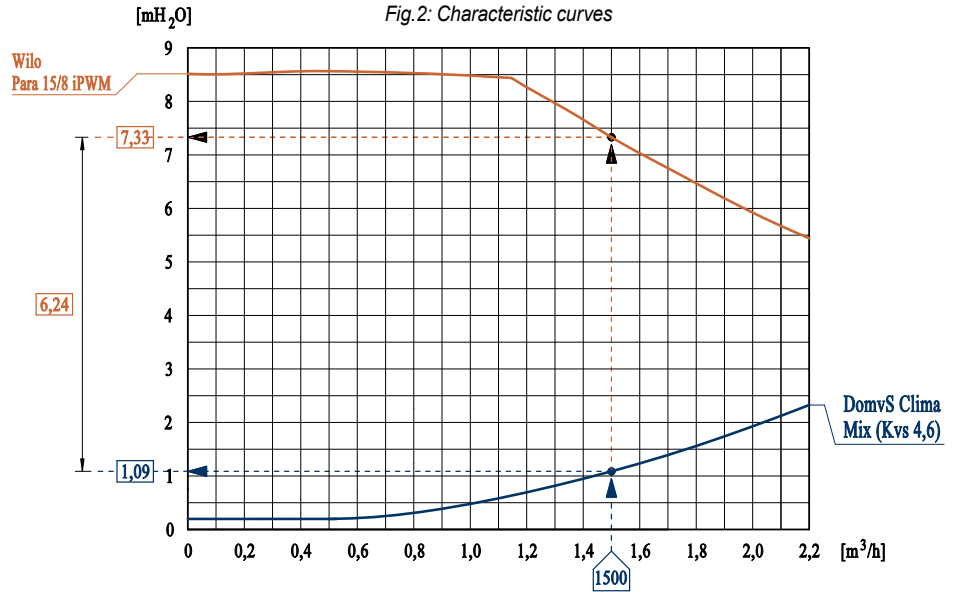

Installation

The hydraulic kit can be installed on the left or on the right of the manifold (in this case, move the thermometer to the rear socket).

- ✓ The Power Box must be fixed to the wall near the kit so that wiring operations can be done smoothly;
- ✓ It is necessary to screw the safety thermostat as shown in Fig.3, and to arrange for its wiring according to the indications shown in the "Wiring" section;
- ✓ Connect the pipes according to the connection scheme, by following the instructions given in Fig.1. Fill the system and, if necessary, de-aerate by acting on the vent valve.

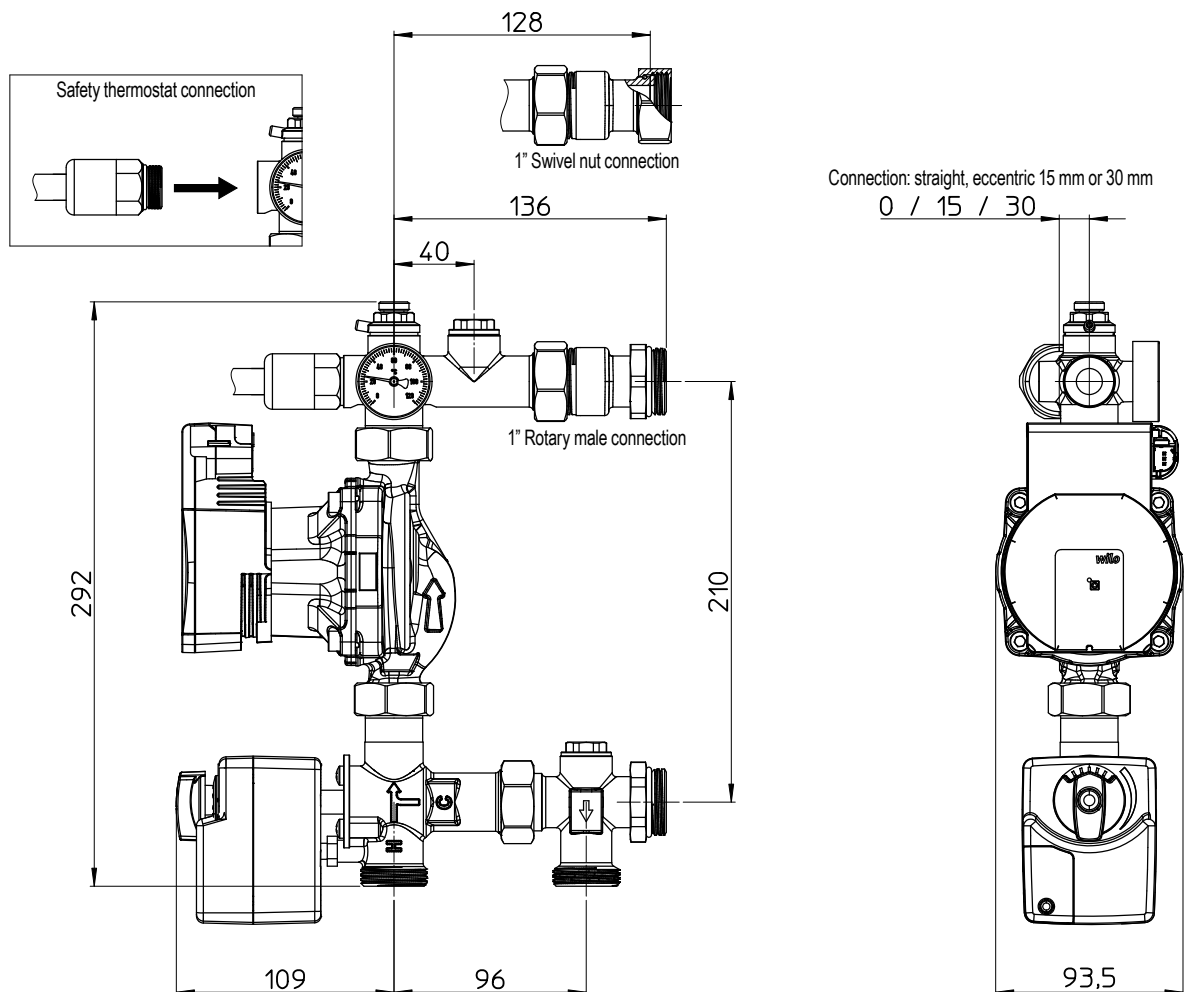

Fig.3: Dimensions layout

DOMVS CLIMA - CONTROL UNIT WITH ROTARY MIXING VALVE

Wiring

The control unit is supplied pre-wired. The power cable must be connected to 230 VAC power supply only after having completed the connection of the safety thermostat and the room thermostat. When connecting the power cable, observe the polarity of **Phase (L)** and **Neutral (N)**.

For a fast and functional connection it is sufficient to insert the cables into the automatic connectors of the Power Box.

To carry out these operations, rely only on qualified personnel.

Proceed with the installation according to all listed below.

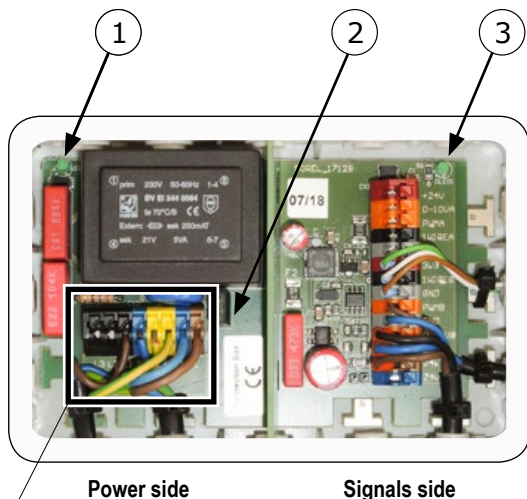
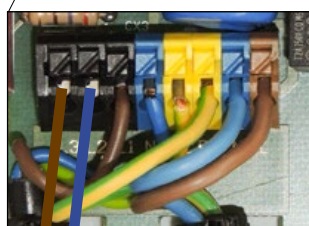

Fig. 4: Power Box



Room thermostat connection



✓ Connections in the Power Box

The Power Box is divided into two parts: power side and signals side.

Power side. In this section the safety thermostat must be connected after having screwed it onto the hydraulic module. It is not necessary to respect the polarity. There is also a LED ① indicating the presence of the power supply.

Signals side. In this section the room thermostat must be connected. Use only a cable for 3x2x0.22 BUS systems. It can be ordered in the company of the desired length (*).

In the circuit a green LED ③ is inserted indicating the presence of 24 V power supply.

(*) Connect five wires as shown in the Fig. 6 (the yellow wire is not used)

LED diagnosis

LED ①	LED ③	Diagnosis
on	on	Proper functioning
off	on	Thermostat intervention
off	off	Fuse to replace (*) or missing power supply
on	off	Transformer failure

(*) T2A 250V fuse

✓ Room thermostat connection

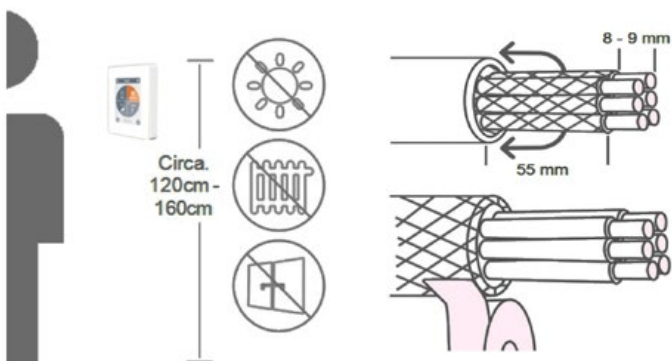
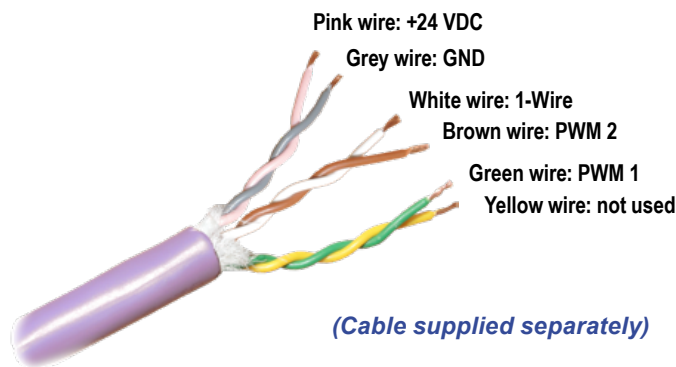

Fig. 5: Room thermostat connection



(Cable supplied separately)



Strip the last 8-9 mm of the wires. Isolate shielding and connect it at a suitable location to the protective conductor. Any contact between protective conductor and circuit board can cause serious damage.

DOMVS CLIMA - CONTROL UNIT WITH ROTARY MIXING VALVE

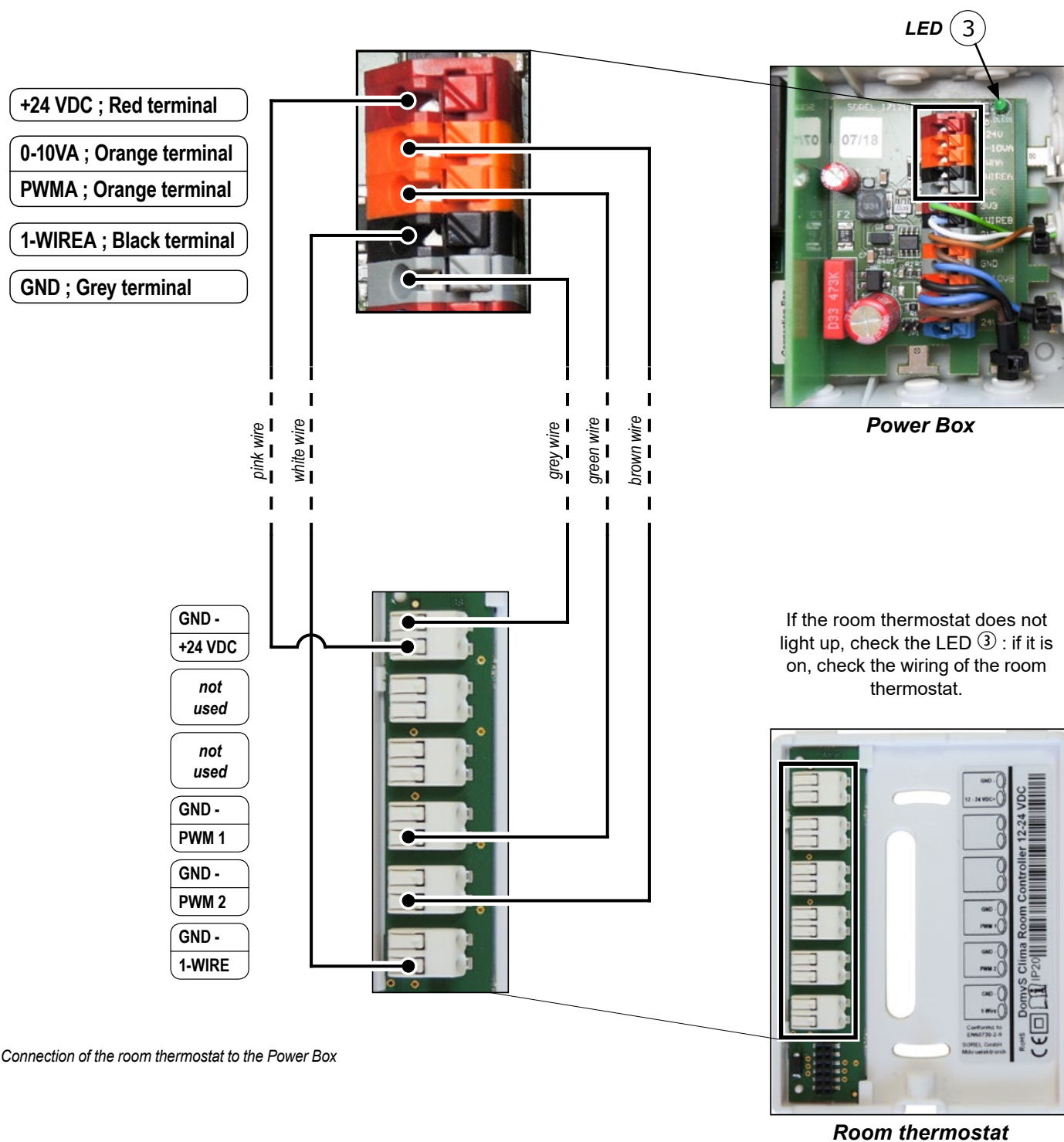



Fig.6: Connection of the room thermostat to the Power Box

Setting up

- ✓ Read carefully the instructions for the control unit;
- ✓ Carry out all connections as indicated in the previous sections;
- ✓ Connect the power cable and PWM control cable to the circulating pump;
- ✓ Connect the control cable to the servomotor with the dedicated connector;
- ✓ Connect the power supply;
- ✓ Wait for the control unit to switch on;
- ✓ Select the language chosen for the interface and follow the instructions of the assistant to start the system step by step.

Electrical connections



DANGER

The pump unit is pre-wired.
Voltage: 230 VAC ± 10%. Frequency: 50+60 Hz.
Maximum absorbed power: 80 W.

DomvS Clima room thermostat controller

Installation

The room thermostat must be installed away from direct sunlight, in an area of the house at medium temperature or where most household activities take place. It must be placed at a height between 120 and 160 cm from the floor, on a wall not in contact with the outside, or nearby to an unheated area, and away from direct heat sources or drafts (doors and windows).

Ignition



→ Date → Time → Daylight saving → ...

... → Valve type

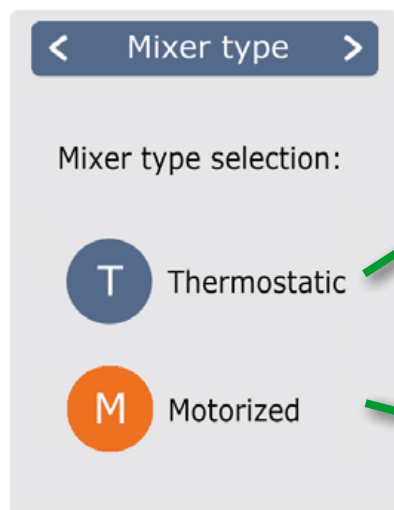

→ ...



... → Insulation



→ End

Programming

Overview of the temperatures and the humidity

Overview

It displays room temperature, humidity and circuit's temperature. If there is no activity for 60 sec., the device is automatically switched to the overview.

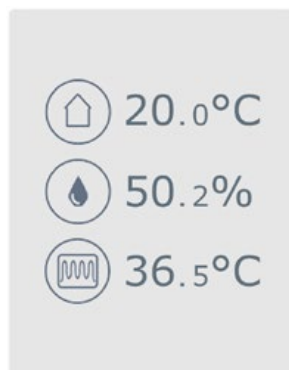

Room temperature

Indicates the room temperature in 0.1°C increments.



Umidità ambiente

It indicates the room umidity in 0.1% increments.



Circuit's temperature

It indicates the circuit's supply temperature, measured by contact probe, in 0.1°C increments.

Select Operating Mode

Overview → Operating Mode

From the Overview you access the Operating Mode by tapping the display



Back

Navigate back to the overview



System type

It identifies the selected system

"M": Rotary mixing valve with servomotor



Minus/Plus

It change the target temperature in +/- 0.5 °C increments.

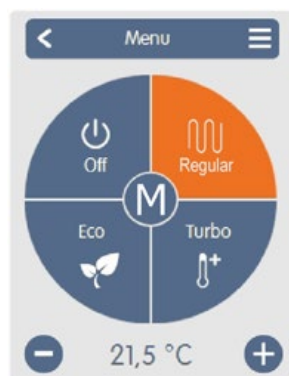

Main menu

Navigate to the main menu



Heating

Cooling

Operating modes

It specifies which operating mode (Normal, Turbo, Eco and Off) is selected. The selected mode is shown in color. By pressing the plus and minus keys it is possible to adjust the setpoint temperature for each of the three modes.

Main Menu

Overview → Operating Mode → Main Menu



Periods

Adjustment of individual heating times for each weekday with copy function for subsequent days.



Holiday

Settings for the period of absence: date and time of period's end, and the temperature.

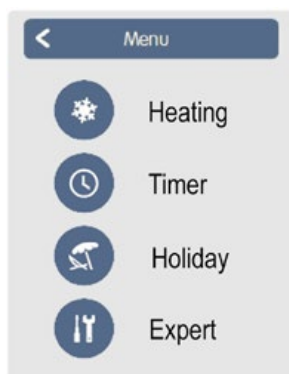

Expert

Standard settings such as language, time and date, working options and factory settings.



Heating / Cooling

It allows to set the operating mode: Cooling (Summer) or Heating (Winter).

Set Operating Hours

Overview → Operating Mode → Main Menu → **Timer**

Adjusting of single heating periods by means of a simple copy function for each day.

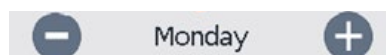

Select the set day.



Operating modes

Select operating mode for each eating period.

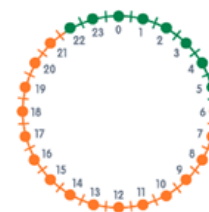

Clock

Time table of the selection in periods of 30 minutes.



Copy menu

It opens the copy function. This function allows you to copy the heating times for the next day, on Monday-Friday or Monday-Sunday.

Example Set Operating Hours

Step 1

Use the arrow keys to select the desired day.



Step 2

Select the first heating mode (Normal); with a continuous touch, scroll the desired time interval, which becomes selected and takes the color of the current operating mode. (e.g. Normal = orange).

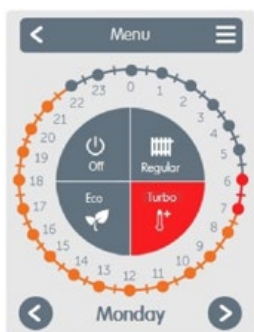

Step 3

Continue to the next mode (Turbo) and proceed as described in the previous step, select the time period for the Turbo Mode.

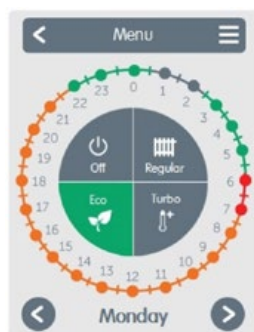

Step 4

Continue to the next mode (Eco) and proceed as described in the previous step, select the time period for the Eco Mode.



Step 5

Continue to the next mode (Off) and proceed as described in the previous step, select the time period for the Off Mode.

Step 6

After the completion of the setting of the individual heating times, it is possible to select periods using the main menu for the next day, or to copy Monday-Friday or Monday-Sunday.

NOTE: For the sake of simplicity, this section describes the procedure for setting the time slots of the thermostat in heating mode. The same operations can also be repeated in cooling mode to create a specific programming.

Holiday

Overview → Operating Mode → Main Menu → **Holiday**

Setting of the holiday period, during which the set temperature is maintained and the antifreeze function is guaranteed.



Holiday off / Expert

It allows, during the set period, to interrupt the holiday mode or to enter the *Expert* menu.

Expert

Overview → Operating Mode → Main Menu → **Expert**

1. Language

Configuration of the device language.

2. Time & Date

The configuration of the time and date and automatic legal time and solar time changeover.

3. DomvS Clima

Settings about basic functions such as calibration, display, messages and advanced system functions.

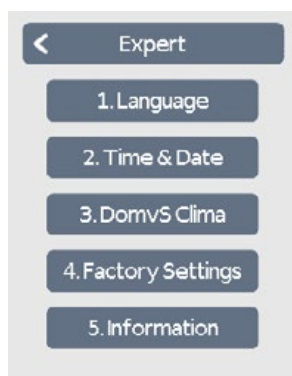

4. Factory Settings

The factory settings are restored in the device.

5. Information

The current software revision, Canbus ID and current date/time of the device are shown.

DomvS Clima

Overview → Operating Mode → Main Menu → Expert → **DomvS Clima**

Sensor Offset

Introduction of a correction shift for the values read by the temperature probes (*) and the humidity probe.

Manage System

Settings about advanced system functions: pump, hysteresis, minimum flow temperature, maximum flow temperature and offset.

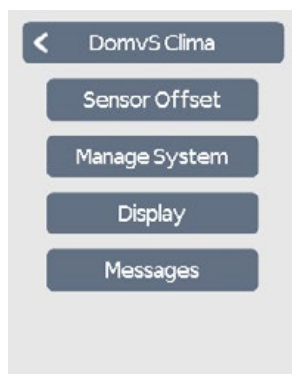

Display

Adjustment of the backlight intensity of the LCD display.

Messages

Error and information messages are shown.

(*) Calibration of the room temperature read. If, despite the recommendations in the "Installation" paragraph, the ambient temperature detected by the device is different from the real one in the environment, it is important to compensate it by using the appropriate parameter in the "Sensor Offset" menu.



DOMVS CLIMA - CONTROL UNIT WITH ROTARY MIXING VALVE

Heating Mode

Overview → Operating Mode → Main Menu → Expert → DomvS Clima → Manage System >> Heating Circuit

Pump

Specify pump speed from 50% to 100%.
Default value is 100%.

Room hysteresis

If room temperature exceeds $T_{set} + \text{Hysteresis}$ value, the mixing valve closes, the pump switches off and reactivates for 5 minutes every hour.
Default value is 1.0 K

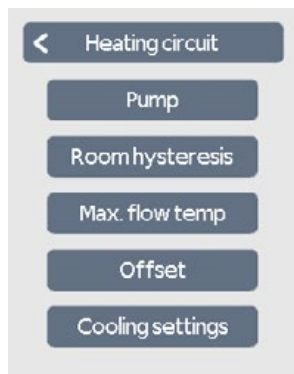

Max. flow temp

If the temperature rises above the set value, the pump is turned off and a message is logged in the "Messages" menu. 50 °C must be selected.

Offset

Mixing valve offset. When the room temperature reaches the $T_{set} - \text{Offset}$ value, the modulation of the flow temperature begins from the maximum to the minimum temperature value.
Default value is 1.0 K

Relationship between degree of insulation and temperature of mixed system

Target temperature of mixing system is set, as follows, according to a linear line, which is calculated by the system.

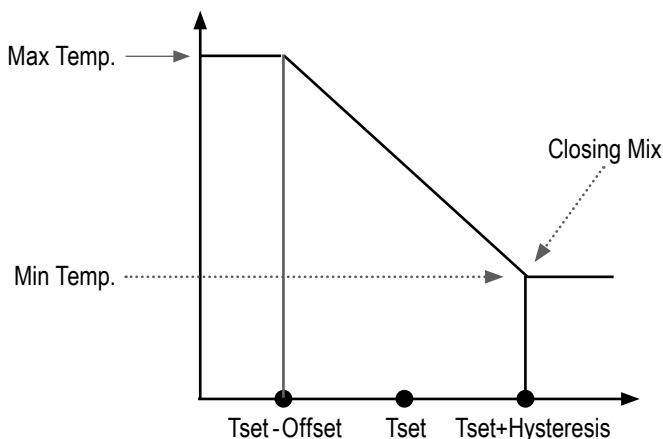

Degree of insulation	Max. temperature mixing system (*)	Min. temperature mixing system (*)
1 Good	35 °C	25 °C
2 Normal	40 °C	28 °C
3 Bad	45 °C	30 °C

(*) These temperature values can't be changed by the user

Tset: is the room temperature set by the user in the various time periods (e.g. 21,5°C).

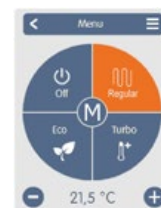

Cooling Mode

Overview → Operating Mode → Main Menu → Expert → DomvS Clima → Manage System >> Heating Circuit → Cooling settings

Min. flow temp

The minimum allowed flow temperature in cooling mode. Default value is: 15 °C.

Max. flow temp

The maximum allowed flow temperature in cooling mode. Default value is: 20 °C.

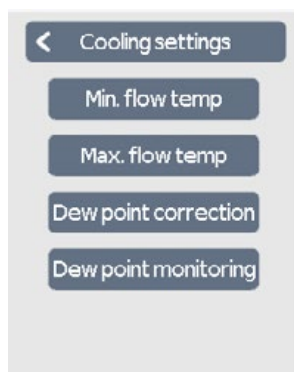

Dew point correction

Sets an offset to the calculated dew point. Default value is: 0 °C.

Dew point monitoring

If the dew point monitoring is "On", the system will not set the flow temp \leq dew point + hysteresis. If the monitoring is "Off", the system will set flow temp = min for cooling. Default: On.